



CS 8200 3D FAMILY
NEO EDITION

Seeing the difference
makes a **difference**

CS 8200 3D

NEO EDITION

Make a difference in every decision

The Neo Edition of the CS 8200 3D is an upgraded version of the initial CBCT system, CS 8200 3D. Maintaining its original versatility and compactness, the Neo Edition offers improved ease of use, a better clinical experience and increased peace of mind, all leading to more successful outcomes for patients and a more successful practice. Practitioners will see the difference in the versatile imaging and will make a difference in every decision they make. This CBCT system includes many improvements upon Caresteam Dental's existing premium imaging and software technologies to offer more in-office services so your practice stands out.

More convenience

A modern user interface and streamlined design means a faster workflow and makes capturing better images effortless

More versatility

Increased capabilities and enhanced functionalities provide more options for your practice and help to expand in-office operations

More peace of mind

Improved outputs to deliver clearer, more precise images, provides peace of mind and ensures positive patient outcomes

Learn more about the [Neo Edition of the CS 8200 3D](#)



“The CS 8200 3D has given me more peace of mind, confidence and the ability to provide better diagnoses. It makes me a more predictable dentist, and I’m able to offer solutions that I couldn’t before.”

Dr. Kamal Singh Missan, D.D.S



Get better results more easily

A new simple and intuitive user interface

Reimagined for convenience and ease of use, our new user interface facilitates staff trainings, ensures consistency of results and increases efficiency of exams. All settings are on the same screen for a faster workflow, and clear instructions indicate which accessories should be used for each exam to avoid positioning errors.

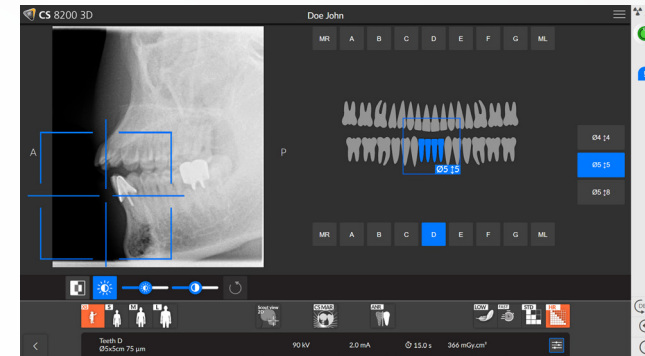
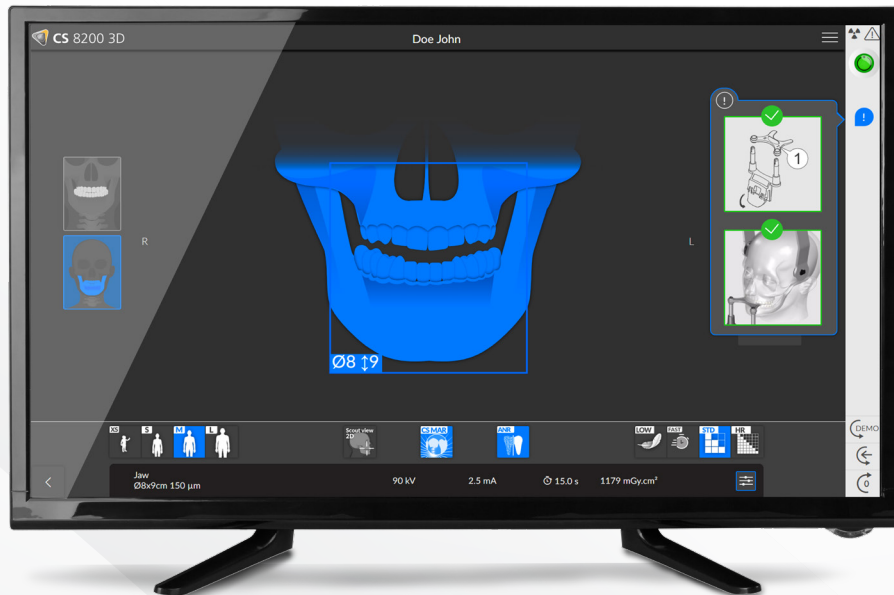

Scout image for better control

Low dose scout image enables you to easily control the imaging area prior to the examination, substantially reducing the need for retakes.



Single-touch repeatability

Access the scanning parameters of a returning patient with the touch of a button, streamlining your workflow and helping you get comparable images over time.

NEW

As versatile as your practice is



Low dose panoramic imaging

The new low dose panoramic mode reduces dose up to 50% while delivering clear images.



5 cm x 8 cm



10 cm x 10 cm

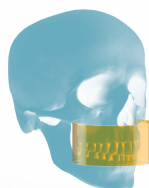

12 cm x 5 cm

Additional field of view options

Three additional field of view (FOV) options enable practitioners to optimize the exposed area and dose or capture opposing teeth for implant cases.

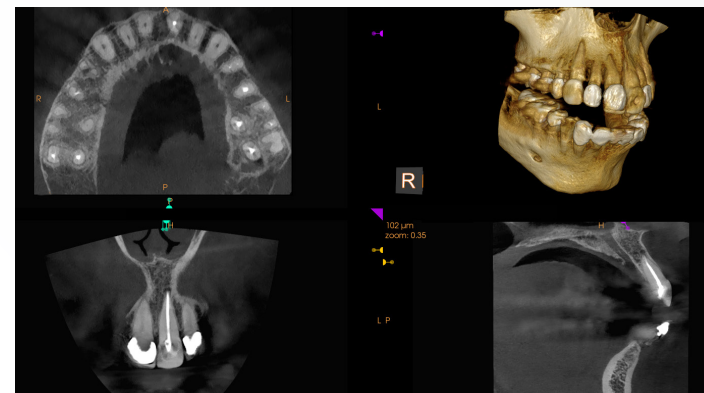

Very high resolution scans

You can now capture 75 microns resolution scans on all fields of view up to 8 cm x 9 cm, providing full-mouth endodontic status at the highest resolution available.

CS UpStream premium service

New CS UpStream¹ premium service. 24/7 advanced monitoring service for your equipment, prevents downtime and maximizes system availability.



¹ CS UpStream is an option of CS Advantage

Expand your vision. **Expand your practice.**

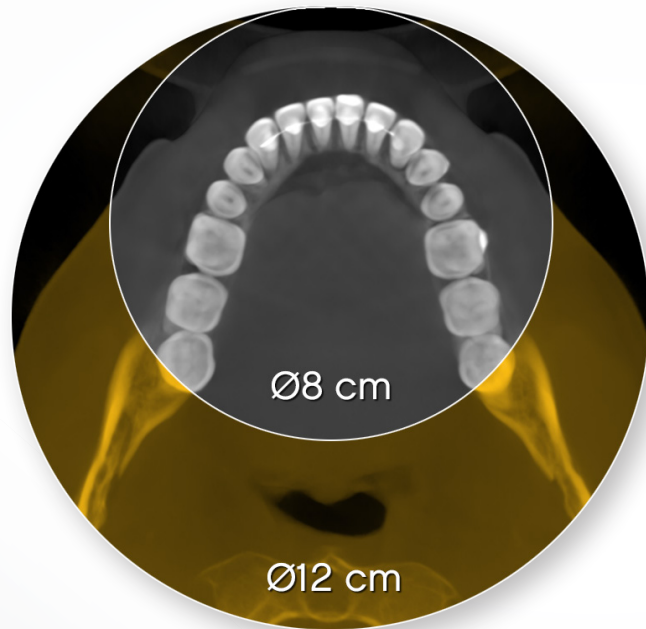

Suits all your clinical needs

The CS 8200 3D features an extended field of view perfectly suited for scanning a full arch in a single scan. 12 cm x 5 cm and 12 cm x 10 cm volumes¹ are ideal for cases involving the entire dentition and for capturing third molars.



4 cm x 4 cm

5 cm x 5 cm

5 cm x 8 cm

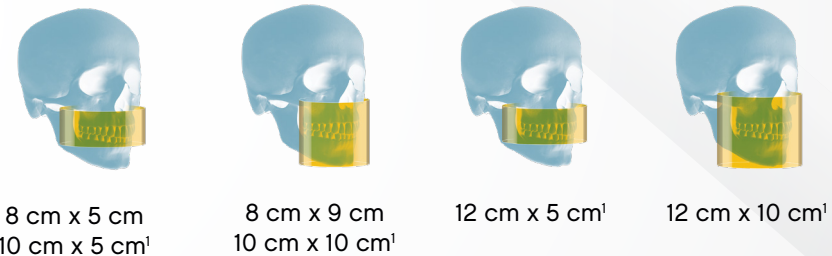

8 cm x 5 cm
10 cm x 5 cm¹

8 cm x 9 cm
10 cm x 10 cm¹

12 cm x 5 cm¹

12 cm x 10 cm¹

The right image at the right dose

The CS 8200 3D is a versatile CBCT system featuring the broadest range of fields of view in its category, ideal for practices that want to expand their treatment capabilities. With up to nine fields of view, you can obtain the ideal image for each individual exam at the lowest dose.

¹ 10 cm x 5 cm, 10 cm x 10 cm, 12 cm x 5 cm and 12 cm x 10 cm are options.
In Ontario (Canada), the use by dentists of FOVs over 8 x 8 cm is subject to conditions.

One compact system, **many possibilities**



A complete range of panoramic programs, including extraoral bitewing, covers all of your routine needs.

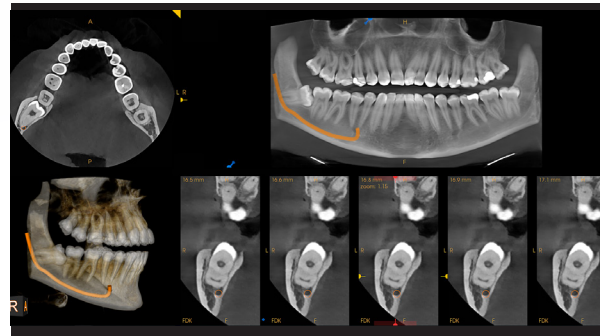

CBCT imaging can be used for a variety of everyday clinical tasks including endodontics, third-molar removal, pre-surgical planning and more.

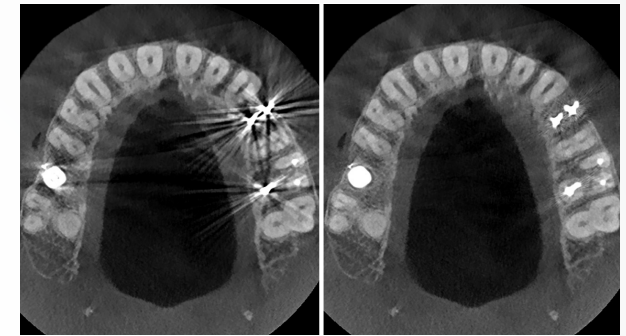

Exclusive CS MAR¹ technology with a live comparison tool allows significant reduction of artifacts caused by implants, fillings or restorations.

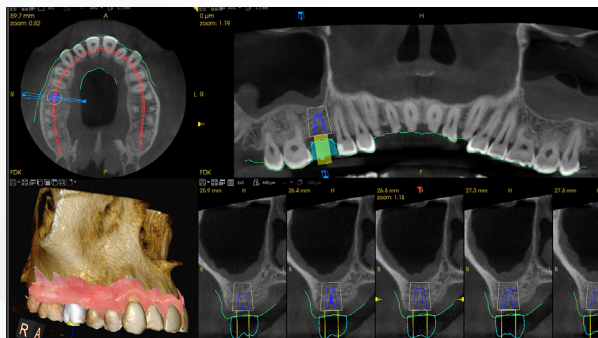

Plan implants with confidence using virtual crowns and a comprehensive implant library.

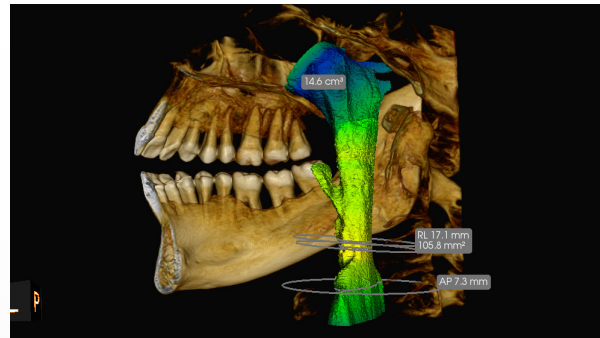

The CS Airway module¹ enables better airway analysis with color-coded, 3D views of the upper airway and automatic measurements.

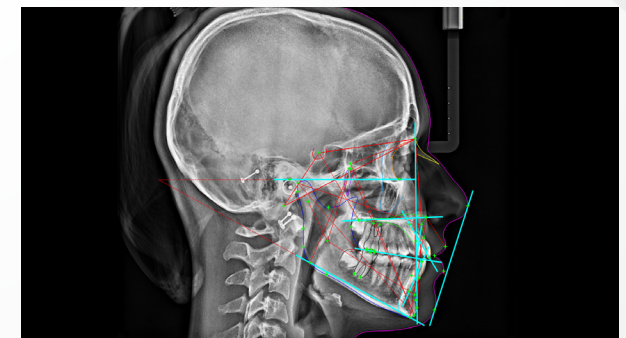

Carestream Dental's automatic tracing feature¹ allows you to fully trace images in just 10 seconds.

¹Option

TECHNICAL SPECIFICATIONS

X-Ray Generator	
Tube voltage	60-90 kV
Tube current	2-15 mA
Frequency	140 kHz
Minimum required space	Without ceph arm: 1200 (L) x 1400 (D) x 2400 (H) mm With ceph arm: 2000 (L) x 1400 (D) x 2400 (H) mm
Weight	Without ceph arm: 95 kg (210 lb.) With ceph arm: 125kg (276 lb.)
3D Modality	
Field Of View diameter x height (cm)	4 x 4 - 5 x 5 - 5 x 8 - 8 x 5 - 8 x 9 ¹ (in Ontario 8 x 8) 10 x 5 ¹ - 10 x 10 ¹ - 12 x 5 ¹ - 12 x 10 ¹
Voxel size (µm)	75 µm minimum
Exposure time	3 to 15 s for FOV < 10 cm (∅) / to 20 s (2 x 10 s) for FOV ≥ 10 cm (∅)
Panoramic Modality	
Magnification	1.2
Radiological exam options	Full panoramic, segmented panoramic (including bitewing segmented panoramic), maxillary sinus, LA TMJ x 2, LA TMJ x 4
Exposure time	2 to 14 seconds
Cephalometric Modality	
Magnification	1.13
Radiological exams	Lateral, frontal AP or PA, oblique, submento-vertex, carpus (optional)
Exposure time	2.9 to 11 seconds

¹ Option

In Ontario (Canada), the use by dentists of FOVs over 8 x 8 cm is subject to conditions

Learn more about the **CS 8200 3D**
by visiting [carestreamdental.com](https://www.carestreamdental.com)

CS 8200 3D WITHOUT CEPHALOMETRIC ARM

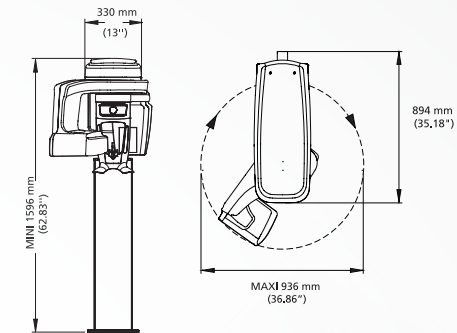

CS 8200 3D WITH CEPHALOMETRIC ARM

